

# Variable speed drives Altivar Easy 310

For applications from 0.37 to 11 kW / 0.5 to 15 HP

Catalog

July 2014



Introducing the **Easy line**  
Essential automation & control products

*When just enough is just right!*

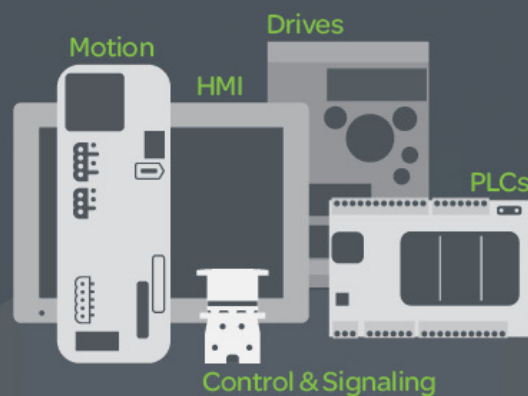

**Schneider**  
Electric



# General contents

## Altivar Easy 310 variable speed drives

■ Variable speed drives .....	page 2
□ Presentation .....	page 2
□ Applications .....	page 2
□ Functions .....	page 2
□ An optimized offer .....	page 3
□ References .....	page 5
■ Configuration tools .....	page 6
□ Simple Loader and Multi-Loader .....	page 6
□ Remote display terminals .....	page 6
■ Options .....	page 7
□ Line chokes, motor chokes and LR filter cells .....	page 7
□ Braking resistors .....	page 8
□ Modbus serial link .....	page 8
■ Motor starters .....	page 9
■ Product reference index .....	page 10

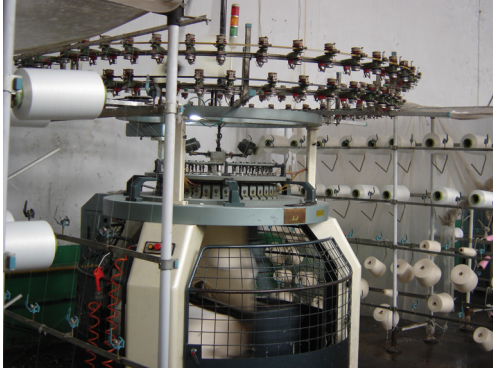

Textile machine

### Presentation

The Altivar™ Easy 310 drive is a frequency inverter for three-phase 380...460 V asynchronous motors rated from 0.37 kW/0.5 HP to 11 kW/15 HP.

The compact size of this drive, its robust design, its ease of installation, based on the principle of Plug & Play, its integrated functions and macro configuration make it particularly suitable for applications involving industrial machines and certain consumer machines.

By taking account of the constraints governing installation and use at the product design stage, we have been able to offer a reliable, cost-effective solution to manufacturers of compact machines (OEMs).

The Altivar Easy 310 has been developed with no compromise on quality : the components are designed to last 10 years.

### Applications

The Altivar Easy 310 drive incorporates functions that are suitable for the most common applications, including:

- Textile machine
- Machine tools
- Wood making machine
- Material handling
- Packaging and printing machines
- Ceramic machine

### Functions

In addition to the functions usually available on this type of drive, the Altivar Easy 310 drive also features the following:

#### Motor control functions (1)

- Motor control profiles: standard, performance and pump/fan
- Cooling fan thermal control
- Switching frequency management
- Boost torque
- Motor noise reduction
- Current limitation
- Auto DC injection

#### Application functions (1)

- Frequency skip
- Preset speeds
- PID regulator
- S ramp, U ramp, ramp switching
- Jog operation
- +/- speed around reference
- Freewheel stop, fast stop
- Automatic catching a spinning load with speed detection and automatic restart

#### Control functions (1)

- Channel configuration - separate mode or not
- Reference channel selection
- Reverse inhibition
- Force local control
- Store customer parameter settings

#### Protection and maintenance functions (1)

- Protection of the installation by means of underload and overload detection
- Maintenance functions:
  - HMI password
  - Configuring the logic and analog I/O
  - Configuring how the parameters are displayed
  - Viewing the state of the logic inputs on the drive display
  - Key parameters display (drive power on / Fan time / Process elapsed time)
  - The last 4 fault display, error log, etc.

(1) For the implementation of functions, please consult the user manual on our local website.



Packaging machine



Printing machine



Altivar Easy 310 range

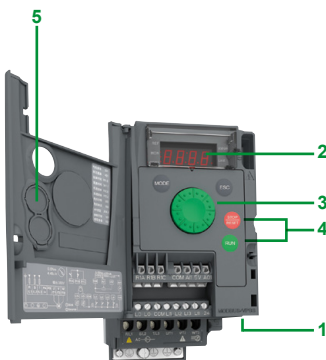

ATV310H037N4E with door on front panel open



Remote terminal with cover closed



Remote terminal with cover open: RUN, FWD/REV and STOP buttons accessible



Multi-Loader configuration tool

### An optimized offer

#### Environment

The entire range conforms to international standards IEC/EN 61800-5-1 and IEC/EN 61800-3 and has been developed to meet the requirements of directives regarding the protection of the environment (RoHS, WEEE). Owing to its innovated air flow design and to its thicker coating which avoids polluting PCB, the range can be used in the harshest environments. It can withstand a 55 °C/131 °F ambient air temperature around the device without derating (1). Its degree of protection is IP 20 (IP 41 on top of the product).

#### Adaptability and performances

The Altivar Easy 310 has been designed with an increased adaptability to different motors and various tough loads.

One of its main quality is its torque capacity for starting and braking:

- Braking capacity:
  - over 80 % of the rated motor torque without braking resistor
  - 150 % of the rated motor torque with braking resistor (see page 8)
- Torque capacity
  - starting torque 150 % at 3 Hz
  - over torque : 150 to 170 %, depending on model (2).

#### Easy to integrate in system

The Altivar Easy 310 drive integrates as standard the Modbus communication protocol, which can be accessed via the RJ45 connector located on the underside of the drive 1 with a 2-wire RS 485 physical interface. To communicate on the network, the Altivar Easy 310 speed drive uses the Modbus RTU transmission mode. For more information on the complementary characteristics of the Modbus port (transmission speed, address, messaging...), please consult our local website. Logic input can be configured as source or sink by software, compatible with many PLCs.

#### Easy to install

The Altivar Easy 310 drives can easily and quickly be installed as:

- they are easy and quick to wire due to their Plug & Play concept
- they can be identified on the front panel.
- they can be mounted side by side to save cabinet space.
- power terminal and connection labels are easily identified and differentiated
- a connection guideline is shown inside the front door.

#### Easy to commission

##### Human-Machine Interface (integrated keypad)

The 4-digit display 2 can be used to display states and faults, access parameters and modify them via the navigation button 3.

The RUN and STOP buttons 4 can be made accessible on the front panel by removing the blanking plate 5 from the door; they must be configured in order to be active.

##### Remote display terminal

The Altivar Easy 310 drive can be connected to a remote display terminal, available as an option. This terminal can be mounted on an enclosure door with IP 54 or IP 65 degree of protection. The maximum operating temperature is 50 °C/122 °F. It provides access to the same functions as the Human-Machine interface.

##### Simple Loader and Multi-Loader configuration tools

The Simple Loader tool enables one powered-up drive's configuration to be duplicated on another powered-up drive. Operation is very simple.

The Multi-Loader tool enables configurations from a PC or drive to be copied and duplicated on another drive; the drives do not need to be powered up. The configuration can be loaded onto the drive without taking it out of its packaging.

#### Easy to maintain

A warning is sent by the drive to the user when it is necessary to clean heat sink or replace cooling fan. This fan, which is the only wearing part, can be changed without the need for any tool.

The security of the system is ensured by an access code allowing authorized people to configure applications and settings in Configuration mode. Simple users are only allowed to use the Monitoring mode (parameters display).

(1) Over this temperature, see the derating curves in the User Manual, available on our website.  
 (2) For more information, please refer to our local website.

### Main characteristics

#### Analog input AI1

1 software-configurable voltage or current analog input:

- Voltage analog input: 0...5 V  $\overline{\text{---}}$  (internal power supply only) or 0...10 V  $\overline{\text{---}}$ , impedance 30 k $\Omega$

- Analog current input: X-Y mA by programming X and Y from 0–20 mA, Impedance 250  $\Omega$

Sampling time: < 20 ms

Resolution: 10 bits

Accuracy:  $\pm 1\%$  at 25 °C/77 °F

Linearity:  $\pm 0.3\%$  of the maximum scale value

Factory setting: Input configured as voltage type

#### Analog output AO1

1 software-configurable voltage or current analog output:

- Analog voltage output: 0...10 V  $\overline{\text{---}}$ , minimum load impedance 470  $\Omega$

- Analog current output: 0–20 mA, maximum load impedance 800  $\Omega$

Sampling time: < 10 ms

Resolution: 8 bits

Accuracy:  $\pm 1\%$  at 25 °C/77 °F

#### Relay outputs R1A, R1B, R1C

1 protected relay output, 1 N/O contact and 1 N/C contact with common point

Response time: 30 ms maximum

Minimum switching capacity: 5 mA for 24 V  $\overline{\text{---}}$

Maximum switching capacity:

- On resistive load ( $\cos \varphi = 1$  and L/R = 0 ms): 3 A at 250 V  $\sim$  or 4 A at 30 V  $\overline{\text{---}}$

- On inductive load ( $\cos \varphi = 0.4$  and L/R = 7 ms): 2 A at 250 V  $\sim$  or 30 V  $\overline{\text{---}}$

#### Logic inputs LI1...LI4

4 programmable logic inputs, compatible with PLC level 1, standard IEC/EN 61131-2 24 V  $\overline{\text{---}}$  internal power supply or 24 V  $\overline{\text{---}}$  external power supply (min. 18 V, max. 30 V)

Sampling time: < 20 ms

Sampling time tolerance:  $\pm 1$  ms

Factory-set with 2-wire control in "transition" mode for machine safety reasons:

- LI1: forward

- LI2...LI4: not assigned

Multiple assignment makes it possible to configure several functions on one input (for example: LI1 assigned to forward and preset speed 2, LI3 assigned to reverse and preset speed 3)

Impedance 3.5 k $\Omega$

#### Logic outputs LO1

One 24 V  $\overline{\text{---}}$  logic output assignable as positive logic (Source) or negative logic (Sink) open collector type, compatible with level 1 PLC, standard IEC/EN 61131-2

Maximum voltage: 30 V

Linearity:  $\pm 1\%$

Maximum current: 10 mA (100 mA with external power supply)

Impedance: 1 k $\Omega$

Update time: < 20 ms



ATV310H037N4E



ATV310HU15N4E



ATV310HU30N4E



ATV310HU75N4E

Drives										
Motor	Line supply					Altivar Easy 310				
Power indicated on rating plate (1)	Max. line current (2)		Apparent power		Max. prospective line Isc	Maximum continuous output current (In) (1)	Maximum transient current for 60 s	Dissipated power at maximum output current (In) (1)	Reference	Weight (3)
	380 V	460 V	460 V			380 V				
kW	HP	A	A	kVA	kA	A	A	W		kg/lb
<b>Three-phase supply voltage: 380...460 V 50/60 Hz</b>										
0.37	0.5	2.1	1.8	1.4	5	1.5	2.3	19.63	ATV310H037N4E	0.800/ 1.760
0.75	1	3.5	3.1	2.5	5	2.3	3.5	28.83	ATV310H075N4E	0.800/ 1.760
1.5	2	6.5	5.4	4.3	5	4.1	6.2	51.82	ATV310HU15N4E	1.100/ 2.430
2.2	3	8.8	7.2	5.7	5	5.5	8.3	66.32	ATV310HU22N4E	1.100/ 2.430
3	4	11.1	9.2	7.3	5	7.1	10.7	80.24	ATV310HU30N4E	1.800/ 3.970
4	5	13.7	11.4	9.1	5	9.5	14.3	102.72	ATV310HU40N4E	1.800/ 3.970
5.5	7.5	21.3	14.3	11.4	22	12.6	18.9	141.54	ATV310HU55N4E	1.800/ 3.970
7.5	10	26.6	22.4	17.8	22	17	25.5	203.87	ATV310HU75N4E	3.700/ 8.160
11	15	36.1	30.4	24.2	22	24	36	294.70	ATV310HD11N4E	3.700/ 8.160

Dimensions (overall)		
Drives with heatsinks	W x H x D	
	mm	in.
ATV310H037N4E	72 x 143 x 130	2.83 x 5.63 x 5.12
ATV310H075N4E	72 x 143 x 140	2.83 x 5.63 x 5.51
ATV310HU15N4E, HU22N4E	105 x 143 x 151	4.13 x 5.63 x 5.94
ATV310HU30N4E...HU55N4E	140 x 184 x 151	5.51 x 7.24 x 5.94
ATV310HU75N4E, HD11N4E	150 x 232 x 171	5.91 x 9.13 x 6.73

(1) These values are given for a nominal switching frequency of 4 kHz, for use in continuous operation. If operation above 4 kHz needs to be continuous, the nominal drive current should be derated by 10% for 8 kHz and 20% for 12 kHz.

The switching frequency can be set between 2 and 12 kHz for all ratings. Above 4 kHz, the drive will reduce the switching frequency automatically in the event of an excessive temperature rise. See the derating curves in the User Manual, available on our local website.

(2) Typical value for the indicated motor power and for the maximum prospective line Isc.

(3) Weight of product without packaging.



#### Configuration tools

Description	For drives	Reference	Weight kg/ lb
<b>Simple Loader, Multi-Loader configuration tools and associated cable</b>			
<b>Simple Loader tool</b> For duplicating one drive configuration on another drive. The drives must be powered-up. The tool is supplied with a cordset equipped with 2 RJ45 connectors.	ATV310H●●●N4E	VW3A8120	—
<b>Multi-Loader tool 1</b> For copying a configuration on a PC or drive and duplicating it on another drive. The drives do not need to be powered-up. Supplied with the tool: <ul style="list-style-type: none"> <li>■ 1 cordset equipped with 2 RJ45 connectors</li> <li>■ 1 cordset equipped with a USB type A connector and a USB Mini-B type connector</li> <li>■ 1 x 2 GB SD memory card</li> <li>■ 1 female/female RJ45 adaptor</li> <li>■ 4 AA/LR6 1.5 V batteries</li> </ul>	ATV310H●●●N4E	VW3A8121	—
<b>Cordset for Multi-Loader tool 2</b> For connecting the Multi-Loader tool to the Altivar Easy 310 drive in its packaging. Equipped with a non-locking RJ45 connector with special mechanical catch on the drive end and an RJ45 connector on the Multi-Loader end.	ATV310H●●●N4E in its packaging	VW3A8126	—



Configuring the drive in its packaging with the Multi-Loader tool VW3A8121+ cordset VW3A8126

#### Remote display terminals and associated cordsets

Description	Degree of protection	For drives	Reference	Weight kg/ lb
<b>Remote display terminals</b> For fixing the Human-Machine interface on an enclosure door with IP 54 or IP 65 degree of protection. A remote-fixing cordset VW3A1104R●● is also required.	IP 54	ATV310H●●●N4E	VW3A1006	0.250/ 0.550
	IP 65	ATV310H●●●N4E	VW3A1007	0.275/ 0.610
<b>Remote-fixing cordsets</b> equipped with 2 RJ45 connectors. For connecting the VW3A1006 or VW3A1007 remote display terminal to the Altivar Easy 310 drive.	Length: 1 m/3.28 ft	ATV310H●●●N4E	VW3A1104R10	0.050/ 0.110
	Length: 3 m/9.84 ft	ATV310H●●●N4E	VW3A1104R30	0.150/ 0.330



VW3A1006 with cover open: RUN, FWD/REV and STOP buttons accessible

#### Dimensions (overall)

Remote display terminal	W x H x D	
	mm	in.
VW3A1006	50 x 70 x 22.7	1.97 x 2.76 x 0.89
VW3A1007	66 x 106 x 26.7	2.6 x 4.17 x 1.05



### Presentation

#### Line chokes

A line choke can be used to provide improved protection against overvoltages on the line supply and to reduce harmonic distortion of the current produced by the drive. They are recommended for ATV310...N4E drives. The recommended chokes limit the line current. They have been developed in line with standard EN 50178 (VDE 0160 level 1 high energy overvoltages on the line supply). The choke values are defined for a voltage drop between phases of between 3% and 5% of the nominal supply voltage. Values higher than this will cause loss of torque. These chokes should be installed upstream of the drive.

The use of line chokes is recommended in particular under the following circumstances:

- Close connection of several drives in parallel
- Line supply with significant disturbance from other equipment (interference, overvoltages)
- Line supply with voltage imbalance between phases above 1.8% of the nominal voltage
- Drive supplied by a line with very low impedance (in the vicinity of a power transformer 10 times more powerful than the drive rating)
- Installation of a large number of frequency inverters on the same line
- Reducing overloads on the cosφ correction capacitors, if the installation includes a power factor correction unit.

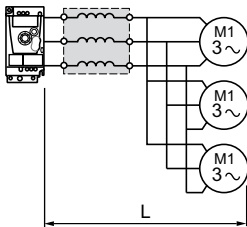

VW3A455●  
Motor choke

#### Motor chokes and LR filter cell

Motor chokes are required:

- When connecting more than 2 motors in parallel
- When the motor cable length (L), including tap-offs, is:
  - 25 m/82.2 ft maximum for a shielded motor cable (1),
  - 50 m/164.4 ft maximum for an unshielded motor cable (1).

LR filter cell comprises 3 high-frequency chokes and 3 resistors.

### References

#### Line chokes

For drives	Line current without choke				Choke	
	380 V		460 V		Reference	Weight
	A	A	A	A		
ATV310H037N4E	2.1	1.8	1.1	1	VW3A4551	1.500/3.310
ATV310H075N4E	3.5	3.1	1.9	1.7		
ATV310HU15N4E	6.5	5.4	3.5	2.9	VW3A4552	3.700/8.160
ATV310HU22N4E	8.8	7.2	5.1	4.4		
ATV310HU30N4E	11.1	9.2	6.6	5.6		
ATV310HU40N4E	13.7	11.4	8.5	7.1	VW3A4553	4.100/9.040
ATV310HU55N4E	21.3	14.3	11.6	9.9		
ATV310HU75N4E	26.6	22.4	15.2	12.8	VW3A4554	6.150/13.230
ATV310HD11N4E	36.1	30.4	22	18.9		

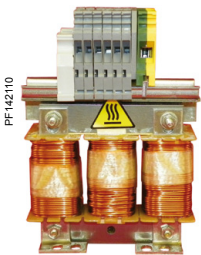

VW3A455●

#### Motor chokes and LR filter cell

For drives	Losses W	Nominal current A	Reference	Weight kg/lb
ATV310H037N4E...HU15N4E	150	10	VW3A58451 (2)	7.400/16.310
ATV310HU22N4E...HU40N4E	65	10	VW3A4552	3.700/8.160
ATV310HU55N4E	75	16	VW3A4553	4.100/9.040
ATV310HU75N4E...HD11N4E	90	30	VW3A4554	6.150/13.230

#### Dimensions (overall)

Line chokes or motor chokes, LR filter cell	W x H x D	
	mm	in.
VW3A4551	100 x 135 x 60	3.94 x 5.31 x 2.36
VW3A4552, A4553	130 x 155 x 90	5.12 x 6.1 x 3.54
VW3A4554	155 x 170 x 135	6.1 x 6.69 x 5.31
VW3A58451	169.5 x 340 x 123	6.67 x 13.39 x 4.84

(1) Motor cable length given for a switching frequency of 4 kHz.

(2) LR filter cell



VW3A7701

Braking resistors						
For drives	Minimum Ohmic value	Ohmic value at			Reference	Weight
		20° C/68 °F	40° C/104 °F	50° C/122 °F (1)		
	Ω	Ω				kg/lb

Not protected resistor (IP00) (2)						
ATV310HU15N4E	80	100	32	28	VW3A7723	0.600/ 1.320
ATV310HU22N4E	60					
ATV310HU30N4E	36	100	40	35	VW3A7725	0.850/ 1.870
ATV310HU40N4E	36					

Protected resistor (IP20 or 23)						
ATV310HU15N4E	80	100	58	50	VW3A7701	1.900/ 4.190
ATV310HU22N4E	60					
ATV310HU30N4E	36					
ATV310HU40N4E	36					
ATV310HU55N4E	28	60	115	100	VW3A7702	2.400/ 5.290
ATV310HU75N4E	28					
ATV310HD11N4E	28	28	231	200	VW3A7703	3.500/ 7.720

Dimensions (overall)		
Braking resistors	W x H x D	
	mm	in.
VW3A7723	60 x 170 x 30	2.36 x 6.659 x 1.18
VW3A7725	62 x 212 x 36	2.44 x 8.35 x 1.42
VW3A7701	95 x 293 x 95	3.74 x 11.54 x 3.74
VW3A7702	95 x 393 x 95	3.74 x 15.47 x 3.74
VW3A7703	140 x 393 x 120	5.51 x 15.47 x 4.72

Modbus serial link				
Description	Item no.	Length m/ft	Unit reference	Weight kg/lb

Connection via splitter box and RJ45 connectors				
<b>Modbus splitter box</b> 10 RJ45 connectors and 1 screw terminal		–	LU9GC3	0.500/ 1.100
<b>Cordsets for Modbus serial link</b> equipped with 2 RJ45 connectors	2	0.3/0.98 1/3.28 3/9.84	VW3A8306R03 VW3A8306R10 VW3A8306R30	0.025/ 0.060 0.060/ 0.130/ 0.290
<b>Modbus T-junction boxes</b> (with integrated cable)	3	0.3/0.98 1/3.28	VW3A8306TF03 VW3A8306TF10	0.190/ 0.420 0.210/ 0.460
<b>Line terminators (5) (6)</b> For RJ45 connector	R = 120 Ω C = 1 nf R = 150 Ω	4 4	VW3A8306RC VW3A8306R	0.010/ 0.020 0.010/ 0.020

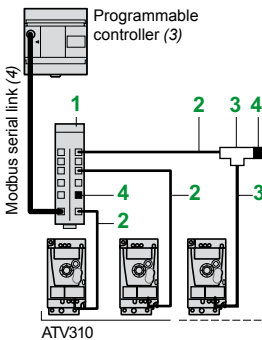

Example of Modbus diagram with connection via splitter box and RJ45 connectors

(1) Load factor for resistors: the value of the average power that can be dissipated at 50 °C from the resistor into the casing is determined for a load factor during braking that corresponds to the majority of normal applications.

For VW3A7701...703:

- 2 s braking with a 0.6 Tn braking torque for a 40 s cycle

- 0.8 s braking with a 1.5 Tn braking torque for a 40 s cycle

(2) For not protected resistors, add a thermal overload device.

(3) Please refer to the programmable controller catalogue on our local website.

(4) Cable depends on the type of controller or PLC.

(5) Order in multiples of 2.

(6) Depends on the bus architecture.

#### Applications

The proposed combinations can:

- Protect people and equipment (when a short-circuit occurs)
- Maintain protection upstream of the drive in the event of a short-circuit on the power stage

Two types of combination are possible:

- Drive + circuit-breaker: Minimum combination
- Drive + circuit-breaker + contactor: Minimum combination with contactor when a control circuit is needed

#### Motor starters

Standard power ratings of three-phase 4-pole 50/60 Hz motors (2)	Variable speed drive	Combination with control circuit (circuit-breaker + contactor)		TeSys contactor (1)
		Minimum combination (circuit-breaker only)	Operating range or rating	
kW HP		TeSys motor circuit-breaker (3)	A	
M1	A1	Q1		KM1
<b>Three-phase supply voltage: 380...460 V 50/60 Hz (4)</b>				
0.37	0.5	ATV310H037N4E	GV2P07 2.5 GV2L07 2.5	LC1D09
0.75	1	ATV310H075N4E	GV2P08 4 GV2L08 4	LC1D09
1.5	2	ATV310HU15N4E	GV2P14 10 GV2L14 10	LC1D09
2.2	3	ATV310HU22N4E	GV2P14 10 GV2L14 10	LC1D09
3	4	ATV310HU30N4E	GV2P16 14 GV2L16 14	LC1D09
4	5.4	ATV310HU40N4E	GV2P16 14 GV2L16 14	LC1D09
5.5	7.4	ATV310HU55N4E	GV2P22 25 GV2L22 25	LC1D09
7.5	10	ATV310HU75N4E	GV2P32 32 GV2L32 32	LC1D18
11	15	ATV310HD11N4E	GV2P40 40 GV2L40 40	LC1D25

(1) For a complete list of references for TeSys contactors, please visit our local website.

(2) Motor power indicated for combination with an ATV310H●●●N4E drive with the same rating.

(3) TeSys motor circuit-breakers:

- GV2 P●●: Thermal magnetic motor circuit-breakers with pushbutton control
- GV2 L●●: Magnetic motor circuit-breakers with control by rotary knob.

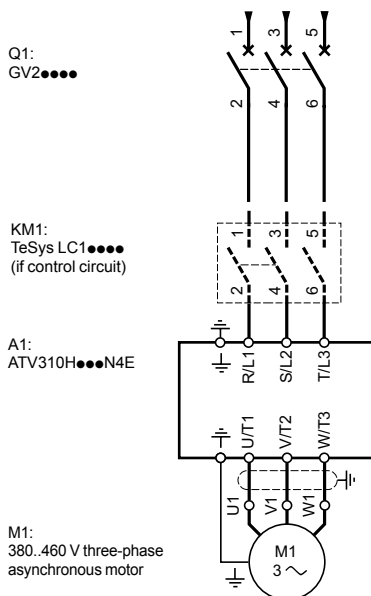

Motor starter with three-phase power supply

---

A	
ATV310H037N4E	5
ATV310H075N4E	5
ATV310HD11N4E	5
ATV310HU15N4E	5
ATV310HU22N4E	5
ATV310HU30N4E	5
ATV310HU40N4E	5
ATV310HU55N4E	5
ATV310HU75N4E	5

L	
LU9GC3	8

V	
VW3A1006	6
VW3A1007	6
VW3A1104R10	6
VW3A1104R30	6
VW3A4551	7
VW3A4552	7
VW3A4553	7
VW3A4554	7
VW3A7701	8
VW3A7702	8
VW3A7703	8
VW3A7723	8
VW3A7725	8
VW3A8120	6
VW3A8121	6
VW3A8126	6
VW3A8306R	8
VW3A8306R03	8
VW3A8306R10	8
VW3A8306R30	8
VW3A8306RC	8
VW3A8306TF03	8
VW3A8306TF10	8
VW3A58451	7





**Schneider Electric Industries SAS**

Head Office  
35, rue Joseph Monier  
F-92500 Rueil-Malmaison  
France

[www.schneider-electric.com](http://www.schneider-electric.com)

The information provided in this documentation contains general descriptions and/or technical characteristics of the performance of the products contained herein. This documentation is not intended as a substitute for and is not to be used for determining suitability or reliability of these products for specific user applications. It is the duty of any such user or integrator to perform the appropriate and complete risk analysis, evaluation and testing of the products with respect to the relevant specific application or use thereof. Neither Schneider Electric nor any of its affiliates or subsidiaries shall be responsible or liable for misuse of the information contained herein.

Design: Schneider Electric  
Photos: Schneider Electric  
Printed by:

DIA2ED2140701EN

July 2014